

591900

Modulo terminale a due derivazioni 180° per collettore componibile.

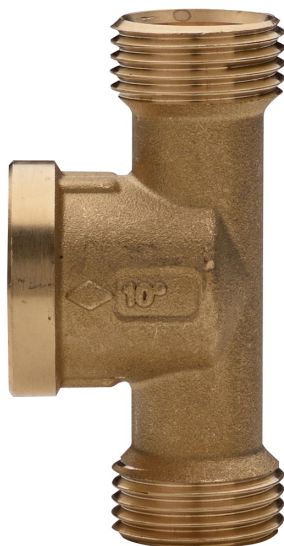

Specifiche tecniche

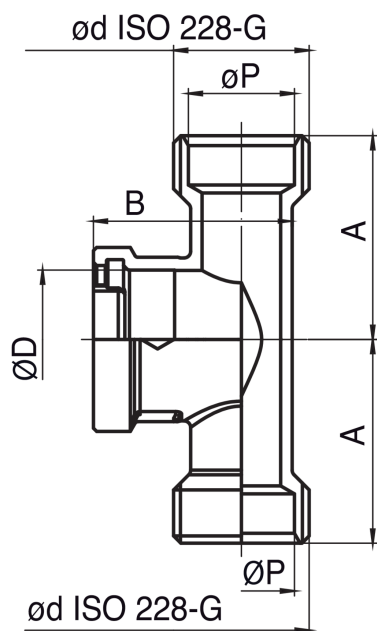

ØD X ØD	BAG	BOX	MASTER BOX	CODICE	ØP	A	B
3/4" x 1/2"	1	15	60	5919002602	16	31	30,4

Applicazioni



DRINKING
WATER



HEATING



HVAC



COMPRESSED
AIR



INDUSTRIAL



MARINE