

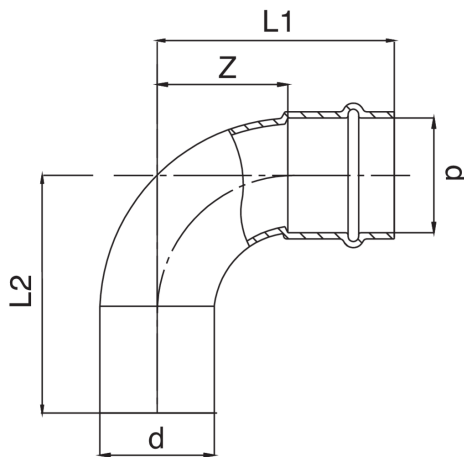

Curva 90° maschio-femmina.

Specifiche tecniche



D	BAG	MASTER BOX	CODICE	L1	L2	Z
15	10	100	GX0001015015000	40	42	18
18	10	100	GX0001018018000	45	47	22
22	5	70	GX0001022022000	51	53	27
28	5	40	GX0001028028000	59	61	34
35	5	10	GX0001035035000	68	70	42
42	1	10	GX0001042042000	87	89	51
54	1	4	GX0001054054000	105	107	65

Applicazioni



GAS



COMPRESSED
AIR



INDUSTRIAL