

RR5130

Raccordo a T femmina ridotto centrale.

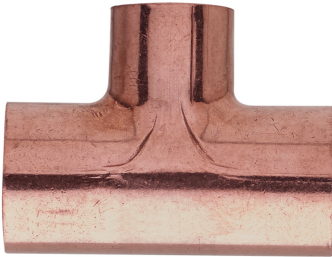

Specifiche tecniche

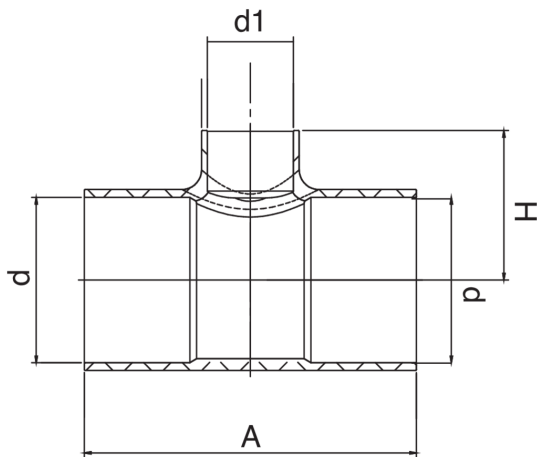

D X D1 X D	BAG	MASTER BOX	CODICE	A	H
8 x 6 x 8	10	500	RR513008006008	27	12
10 x 6 x 10	10	600	RR513001006010	29	12
10 x 8 x 10	10	500	RR5130010008010	28	13
12 x 6 x 12	10	400	RR5130012006012	29	14,5
12 x 8 x 12	10	450	RR5130012008012	29	14,5
12 x 10 x 12	10	400	RR5130012010012	30	17
14 x 10 x 14	10	300	RR5130014010014	33,5	16
14 x 12 x 14	10	300	RR5130014012014	35,5	17,5
15 x 8 x 15	10	300	RR5130015008015	32	16
15 x 10 x 15	10	300	RR5130015010015	33,5	17,5
15 x 12 x 15	10	200	RR5130015012015	35	18
16 x 10 x 16	10	250	RR5130016010016	34	17
16 x 12 x 16	10	250	RR5130016012016	36	18
16 x 14 x 16	10	200	RR5130016014016	38	20
18 x 10 x 18	10	350	RR5130018010018	37	18,5
18 x 12 x 18	10	250	RR5130018012018	39	19
18 x 14 x 18	10	300	RR5130018014018	41	21
18 x 15 x 18	10	180	RR5130018015018	42	21
18 x 16 x 18	10	300	RR5130018016018	43	22
20 x 14 x 20	10	250	RR5130020014020	47	23,5
20 x 18 x 20	10	200	RR5130020018020	52	26
22 x 10 x 22	10	250	RR5130022010022	44	20
22 x 12 x 22	10	250	RR5130022012022	46	21
22 x 14 x 22	10	200	RR5130022014022	48	23
22 x 15 x 22	10	100	RR5130022015022	47	23
22 x 16 x 22	10	200	RR5130022016022	48	24
22 x 18 x 22	10	100	RR5130022018022	50	25
22 x 20 x 22	10	200	RR5130022020022	52	27
28 x 10 x 28	10	200	RR5130028010028	50	24
28 x 12 x 28	10	200	RR5130028012028	52	24,5
28 x 14 x 28	10	200	RR5130028014028	52	26
28 x 15 x 28	10	150	RR5130028015028	53	26,5
28 x 16 x 28	10	200	RR5130028016028	55	27
28 x 18 x 28	10	180	RR5130028018028	56	28
28 x 20 x 28	10	180	RR5130028020028	60	31
28 x 22 x 28	10	130	RR5130028022028	60	31
32 x 16 x 32	10	100	RR5130032016032	65	29
32 x 18 x 32	10	100	RR5130032018032	66	30,5
32 x 22 x 32	10	100	RR5130032022032	70	33,5
32 x 28 x 32	5	80	RR5130032028032	76	36
35 x 12 x 35	5	100	RR5130035012035	62	28,5
35 x 15 x 35	5	100	RR5130035015035	63	30,5
35 x 18 x 35	5	100	RR5130035018035	66	33
35 x 22 x 35	5	80	RR5130035022035	70	35,5
35 x 28 x 35	5	70	RR5130035028035	76,5	38
36 x 16 x 36	5	100	RR5130036016036	65	30
36 x 18 x 36	5	100	RR5130036018036	66	31
36 x 22 x 36	5	100	RR5130036022036	71	35
36 x 28 x 36	5	100	RR5130036028036	78	38
36 x 32 x 36	5	70	RR5130036032036	79	40
40 x 32 x 40	5	50	RR5130040032040	89	46
40 x 36 x 40	5	50	RR5130040036040	90	46
42 x 15 x 42	5	70	RR5130042015042	71	34,5
42 x 18 x 42	5	70	RR5130042018042	74	38
42 x 22 x 42	5	60	RR5130042022042	78	39,5
42 x 28 x 42	5	50	RR5130042028042	84	42
42 x 32 x 42	5	40	RR5130042032042	90	46,5
42 x 35 x 42	5	40	RR5130042035042	91	47
52 x 28 x 52	5	10	RR5130052028052	95	47

Applicazioni



DRINKING WATER



HEATING



HVAC



GAS



COMPRESSED AIR



SOLAR



INDUSTRIAL