

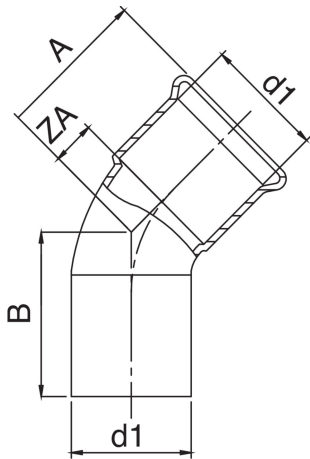

Courbe 45° M/F.



Spécifications techniques



D1	BAG	MASTER BOX	CODE	A	B	ZA
66,7	1	10	AC0040067067000	78	88	33
76,1	1	10	AC0040076076000	93	104	38
88,9	1	6	AC0040089089000	104	115	44
108	1	2	AC0040108108000	124	136	68

Applications



HEATING



HVAC



COMPRESSED
AIR