

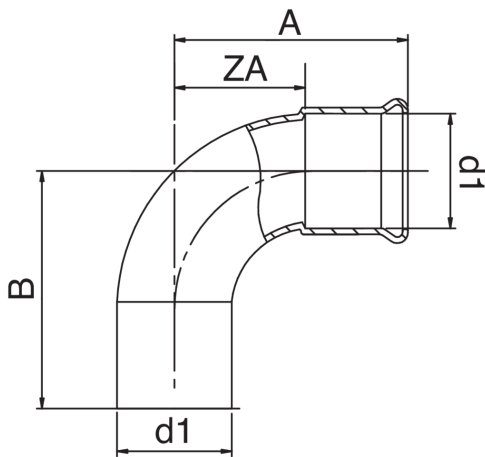

Courbe 90° M/F en cuivre.



Spécifications techniques



D1	BAG	MASTER BOX	CODE	A	B	ZA
66,7	1	6	RR9001067067000	135	145	80
76,1	1	6	RR9001076076000	146	157	91
88,9	1	5	RR9001089089000	167	178	107
108	1	1	RR9001108108000	200	212	130

Applications



DRINKING
WATER



HEATING



HVAC



COMPRESSED
AIR



FIREFIGHTING