

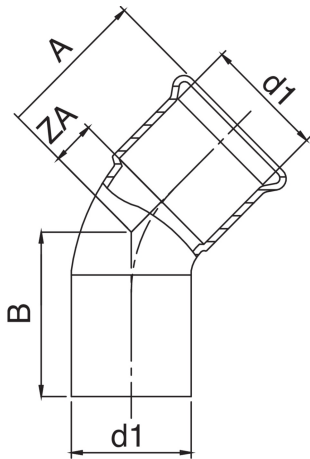

Courbe 45° M/F.



Spécifications techniques



D1	BAG	MASTER BOX	CODE	A	B	ZA
15	10	200	CM0040015015000	28	37	9
18	10	150	CM0040018018000	29	37	10
22	10	100	CM0040022022000	34	42	13
28	5	60	CM0040028028000	37	42	15
35	5	40	CM0040035035000	44	46	19
42	5	20	CM0040042042000	51	68	22
54	1	10	CM0040054054000	62	72	28

Applications



HEATING



HVAC



COMPRESSED
AIR