

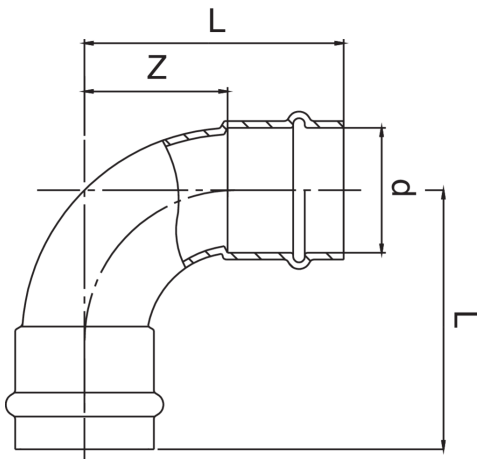

Spécifications techniques



D	BAG	MASTER BOX	CODE	L	Z
12	10	150	ZC0002012012000	33	15
15	10	150	ZC0002015015000	40	18
18	10	100	ZC0002018018000	45	22
22	10	60	ZC0002022022000	50	26
28	5	40	ZC0002028028000	59	34
35	5	30	ZC0002035035000	68	42
42	1	10	ZC0002042042000	87	51
54	1	7	ZC0002054054000	105	65

Applications



HEATING



HVAC



COMPRESSED
AIR