

Courbe 45° M/F en cuivre.

Spécifications techniques

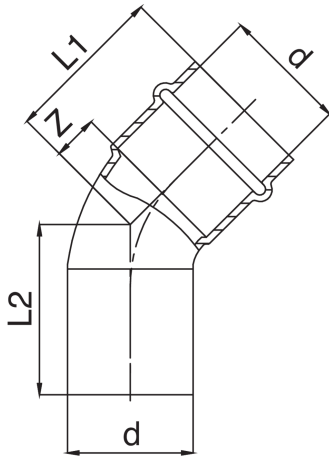

D	BAG	MASTER BOX	CODE	L1	L2	Z
12	10	250	PG9040012012000	25	26	7
15	10	200	PG9040015015000	29	30	7
18	10	150	PG9040018018000	31	32	8
22	10	100	PG9040022022000	34	36	10
28	5	60	PG9040028028000	38	40	13
35	5	40	PG9040035035000	43	45	17
42	5	20	PG9040042042000	53	55	17
54	1	10	PG9040054054000	68	70	28

Applications



GAS



INDUSTRIAL



COMPRESSED
AIR