

9F56

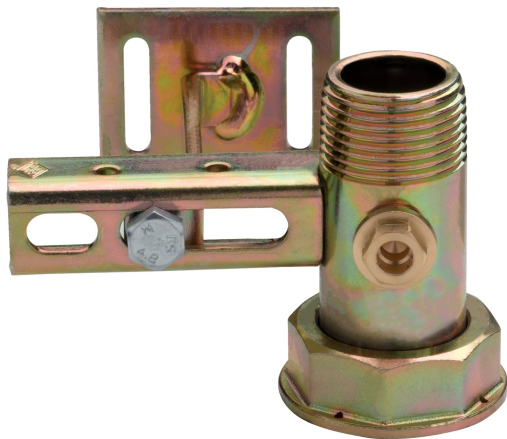

Traverse en acier, entre-axes 110 mm, avec raccord et prise de pression, taraudée EN 10226-1, avec support pour vis murale h.85.



Spécifications techniques

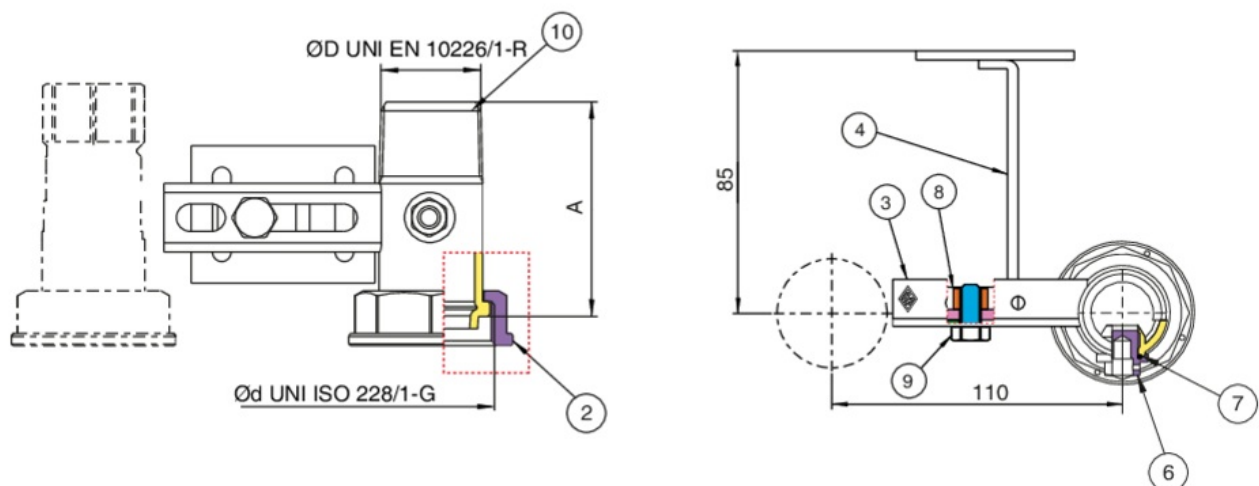

ØD X ØD	MASTER BOX	CODE	A
1" x 1"1/4	25	9F56290000	70,5

Applications



GAS