

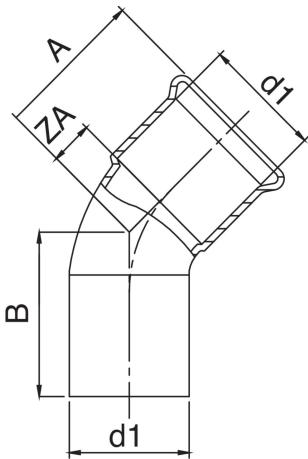

Curva 45° M/H de cobre.



Especificaciones técnicas



D1	BAG	MASTER BOX	CÓDIGO	A	B	ZA
66,7	1	10	RR9040067067000	78	88	33
76,1	1	10	RR9040076076000	93	104	38
88,9	1	5	RR9040089089000	104	115	44
108	1	3	RR9040108108000	124	136	68

Aplicaciones



DRINKING
WATER



HEATING



HVAC



COMPRESSED
AIR



FIREFIGHTING