

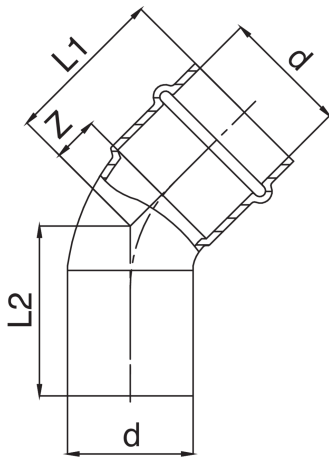

Especificaciones técnicas



D	BAG	MASTER BOX	CÓDIGO	L1	L2	Z
12	10	250	ZC0040012012000	25	27	7
15	10	200	ZC0040015015000	29	31	7
18	10	150	ZC0040018018000	31	33	8
22	10	100	ZC0040022022000	34	36	10
28	5	60	ZC0040028028000	38	40	13
35	5	40	ZC0040035035000	43	45	17
42	5	20	ZC0040042042000	53	55	17
54	1	10	ZC0040054054000	68	70	28

Aplicaciones

