

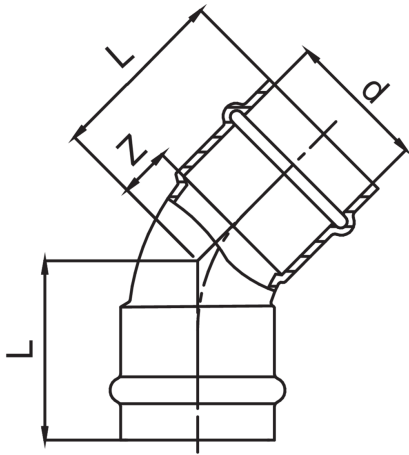

Curva 45° H/H.

## Especificaciones técnicas



D	BAG	MASTER BOX	CÓDIGO	L	Z
15	10	100	GX0041015015000	29	7
18	5	30	GX0041018018000	46	23
22	5	50	GX0041022022000	34	10
28	5	40	GX0041028028000	38	13
35	5	40	GX0041035035000	43	17
42	1	20	GX0041042042000	53	17
54	1	5	GX0041054054000	69	29

## Aplicaciones



GAS



COMPRESSED  
AIR



INDUSTRIAL