

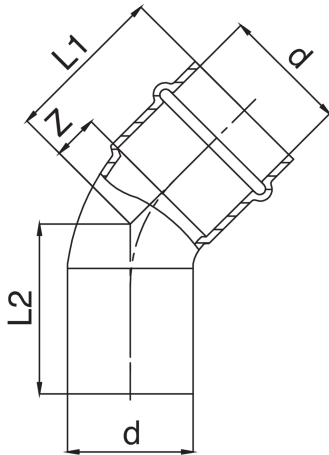

Curva 45° M/H de cobre.



Especificaciones técnicas



D	BAG	MASTER BOX	CÓDIGO	L1	L2	Z
12	10	250	RK9040012012000	25	26	7
15	10	200	RK9040015015000	29	30	7
18	10	150	RK9040018018000	31	32	8
22	10	100	RK9040022022000	34	36	10

Aplicaciones

