

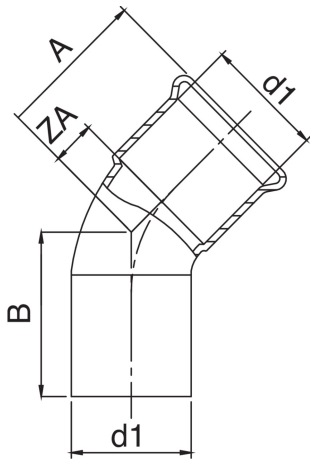

Curva 45° M/H de cobre.



Especificaciones técnicas



D1	BAG	MASTER BOX	CÓDIGO	A	B	ZA
12	10	250	ZM9040012012000	23	30	5
15	10	200	ZM9040015015000	28	37	8
18	10	150	ZM9040018018000	29	37	9
22	10	100	ZM9040022022000	34	42	11
28	5	60	ZM9040028028000	37	42	14
35	5	40	ZM9040035035000	44	46	18
42	5	20	ZM9040042042000	51	68	21
54	1	10	ZM9040054054000	62	72	27

Aplicaciones



DRINKING
WATER



HEATING



HVAC



COMPRESSED
AIR



FIREFIGHTING