

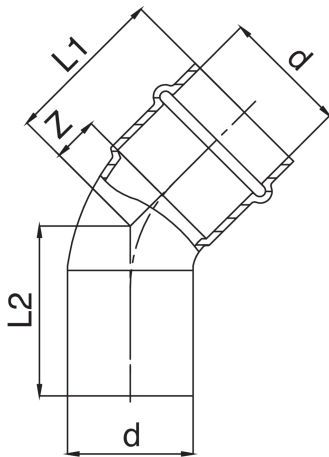

Especificaciones técnicas



D	BAG	MASTER BOX	CÓDIGO	L1	L2	Z
15	10	40	ZX0040015015000	29	30	7
18	10	100	ZX0040018018000	31	32	8
22	10	60	ZX0040022022000	34	35	10
28	5	40	ZX0040028028000	38	39	13
35	5	30	ZX0040035035000	43	44	17
42	1	20	ZX0040042042000	53	54	17
54	1	10	ZX0040054054000	69	70	29

Aplicaciones



DRINKING
WATER



HEATING



HVAC



COMPRESSED
AIR



FIREFIGHTING



MARINE



STEAM



SOLAR



INDUSTRIAL