

9F56

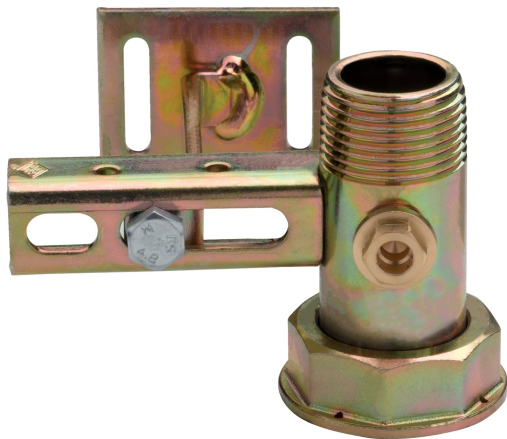

Traversa en hierro, distancia 110 mm con anillo roscado/rosca EN 10226-1 y conexión presión h.85 por juegos d'expansion.



Especificaciones técnicas

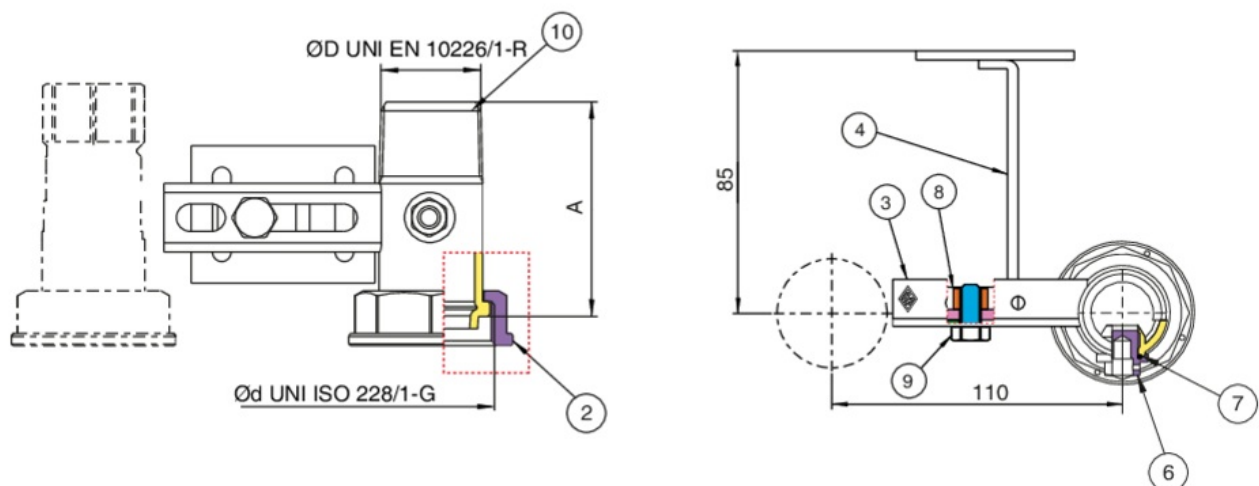

ØD X ØD	MASTER BOX	CÓDIGO	A
1" x 1"1/4	25	9F56290000	70,5

Aplicaciones



GAS