

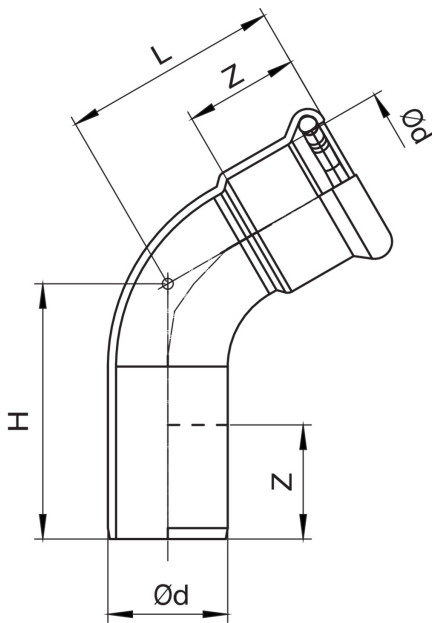

M/F 60° elbow.

Technical specifications



D	BAG	MASTER BOX	CODE	L	H	Z
15	10	250	5N390015	34	40,5	19
18	10	250	5N390018	36	42,5	19,5
22	5	120	5N390022	42,5	49,5	21
28	5	60	5N390028	46,5	54	22
35	5	50	5N390035	69	75,5	27
42	2	24	5N390042	88,5	95	30
54	2	16	5N390054	112,5	119	35
76,1	1	5	5N390076	120	126	54
88,9	1	3	5N390088	137	145	61
108	1	2	5N390108	181,5	189,5	76

Applications



MARINE