

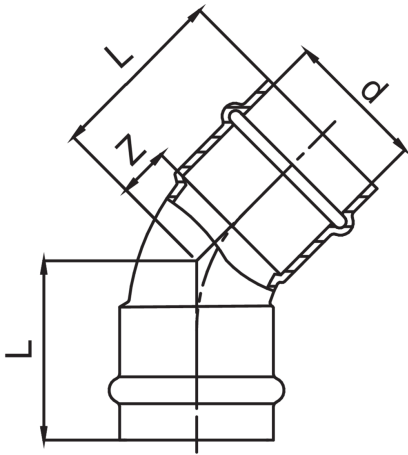

Copper F/F 45° elbow.

Technical specifications



D	BAG	MASTER BOX	CODE	L	Z
12	10	250	PG9041012012000	25	7
15	10	200	PG9041015015000	29	7
18	10	150	PG9041018018000	31	8
22	10	80	PG9041022022000	34	10
28	5	60	PG9041028028000	38	13
35	5	40	PG9041035035000	43	17
42	5	20	PG9041042042000	53	17
54	1	10	PG9041054054000	68	28

Applications



GAS



INDUSTRIAL



COMPRESSED
AIR