

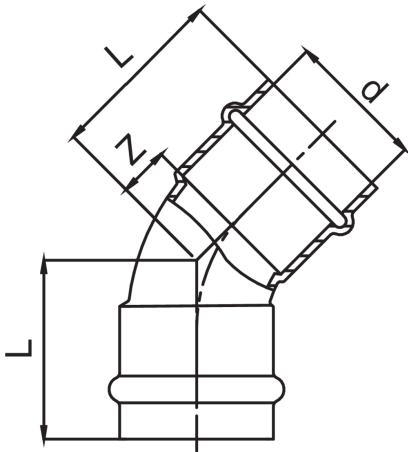

F/F 45° elbow.



Technical specifications



D	BAG	MASTER BOX	CODE	L	Z
12	10	200	ZC0041012012000	25	7
15	10	200	ZC0041015015000	29	7
18	10	150	ZC0041018018000	31	8
22	10	80	ZC0041022022000	34	10
28	5	60	ZC0041028028000	38	13
35	5	40	ZC0041035035000	43	17
42	5	20	ZC0041042042000	53	17
54	1	10	ZC0041054054000	68	22

The big-size, item AC0041, is available.

Applications



HEATING



HVAC



COMPRESSED
AIR