

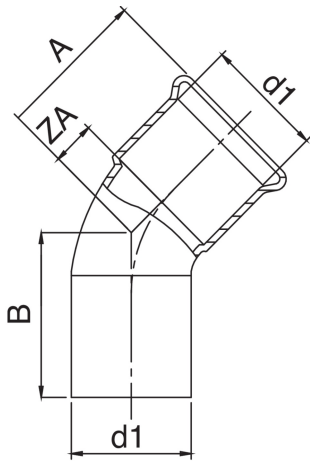

Technical specifications



D1	BAG	MASTER BOX	CODE	A	B	ZA
76,1"	1	10	AC0040076076000	93	104	38
88,9"	1	6	AC0040089089000	104	115	44
108"	1	2	AC0040108108000	124	136	68

Applications



HEATING



HVAC



COMPRESSED
AIR