

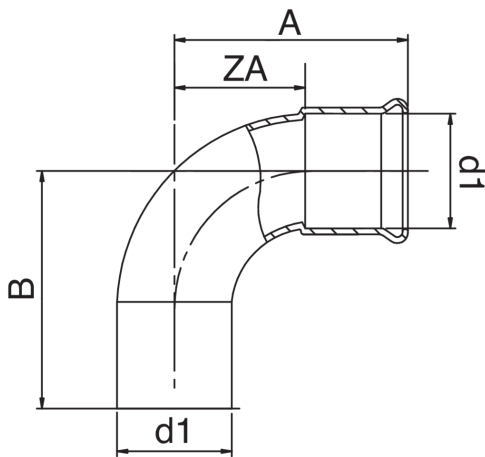

Bogen 90° I/A.



Technische Spezifikationen



D1	BAG	MASTER BOX	CODE	A	B	ZA
66,7	1	10	AC0001067067000	135	145	80
76,1	1	6	AC0001076076000	146	157	91
88,9	1	4	AC0001089089000	167	178	107
108	1	2	AC0001108108000	200	212	130

Anwendungen



HEATING



HVAC



COMPRESSED
AIR