

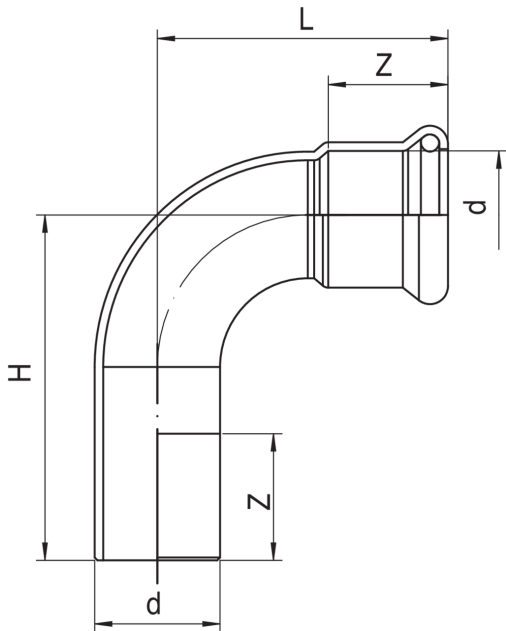

Bogen 90° 1/2".

Technische Spezifikationen



D	BAG	MASTER BOX	CODE	L	H	Z
15	10	250	5N130015	41	47,5	19
18	10	250	5N130018	45	51,5	19,5
22	5	120	5N130022	51	57,5	21
28	5	60	5N130028	60,5	66,5	22
35	5	40	5N130035	76,5	83	27
42	2	20	5N130042	96	102,5	30
54	2	12	5N130054	124,5	131,5	35
76,1	1	5	5N130076	160	166	54
88,9	1	2	5N130088	185	193	61
108	1	1	5N130108	250	258	76

Anwendungen



MARINE