

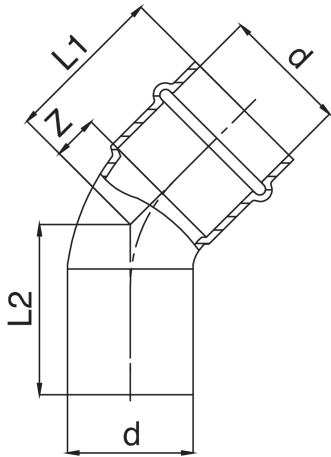

Bogen 45° I/A.

## Technische Spezifikationen



D	BAG	MASTER BOX	CODE	L1	L2	Z
15	10	40	GX0040015015000	29	30	7
18	10	100	GX0040018018000	31	32	8
22	10	60	GX0040022022000	34	35	10
28	5	40	GX0040028028000	38	39	13
35	5	30	GX0040035035000	43	44	17
42	1	20	GX0040042042000	53	54	17
54	1	5	GX0040054054000	69	70	29

## Anwendungen



GAS



COMPRESSED  
AIR



INDUSTRIAL