

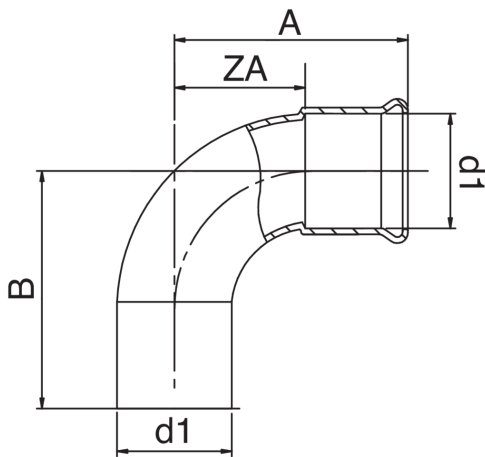

Bogen 90° I/A aus Kupfer.



Technische Spezifikationen



D1	BAG	MASTER BOX	CODE	A	B	ZA
12	10	300	ZM9001012012000	31	40	13
15	10	200	ZM9001015015000	36	42	16
18	10	150	ZM9001018018000	41	50	21
22	10	80	ZM9001022022000	46	53	23
28	5	40	ZM9001028028000	57	60	34
35	5	30	ZM9001035035000	62	75	36
42	1	10	ZM9001042042000	76	94	46
54	1	7	ZM9001054054000	94	110	59

Anwendungen



DRINKING
WATER



HEATING



HVAC



COMPRESSED
AIR



FIREFIGHTING