

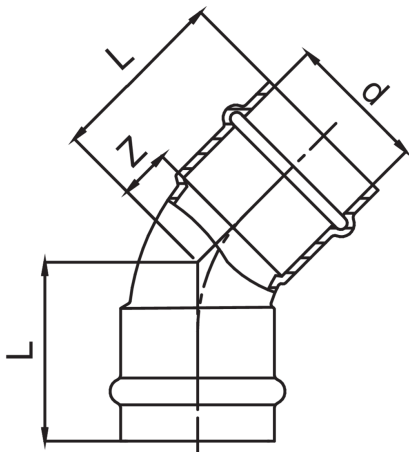

Technische Spezifikationen



D	BAG	MASTER BOX	CODE	L	Z
15	10	100	ZX0041015015000	29	7
18	5	150	ZX0041018018000	46	23
22	5	50	ZX0041022022000	34	10
28	5	40	ZX0041028028000	38	13
35	5	40	ZX0041035035000	43	17
42	1	20	ZX0041042042000	53	17
54	1	5	ZX0041054054000	69	29

Anwendungen



DRINKING
WATER



HEATING



HVAC



COMPRESSED
AIR



FIREFIGHTING



MARINE



STEAM



SOLAR



INDUSTRIAL